

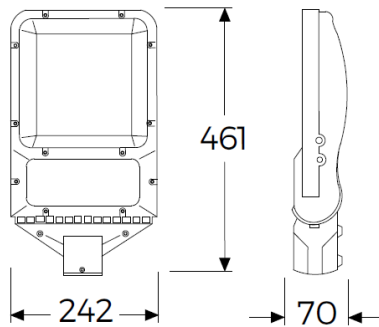

STATE

GSA 3518BL SG40



Product Features and Key Data

Applications :	Highways, storage locations, terminals, parking lots, power station
Luminaire Type :	LED Streetlight
Mounting Method :	On pole
Luminaire Optic :	Tempered glass with lens
Connected Load :	180W
Colour Temperature :	4000K
Rated Luminous Flux :	18000 lm
Luminous Efficiency :	100 lm/W
Power Factor :	> 0,977
CRI Value :	> 80
UGR :	< 21 (EN124664-1)
Photo Biological Class :	Group 0 - No risk
Luminaire Colour :	Grey color
Luminaire Body :	Robust die cast body. Electrostatic powder coating
Electrical version :	With electronic transformer, switchable.
Connection method :	Terminal
Mains frequency :	50/60 Hz
Mains voltage :	220 - 240 V
Led Service (25°) :	L80 = 50.000 h
Driver (220 - 240V) :	Tridonic, Osram or equivalent
Ceiling Type :	AB - Gypsum Ceiling TB - Modular Ceiling KB - Clip-in Ceiling
Ingress Protection (IP) rating :	IP65
Protection class :	I
Impact resistance (IK) :	IK08
Hot wire resistance :	650 °C
Ambient temperature :	- 35 - 40 °C
Options :	1 - 3 Hours Emergency Kit, Dali Dimmible
Accessories :	